

RevNO	Revisions	DATE	CHECKED

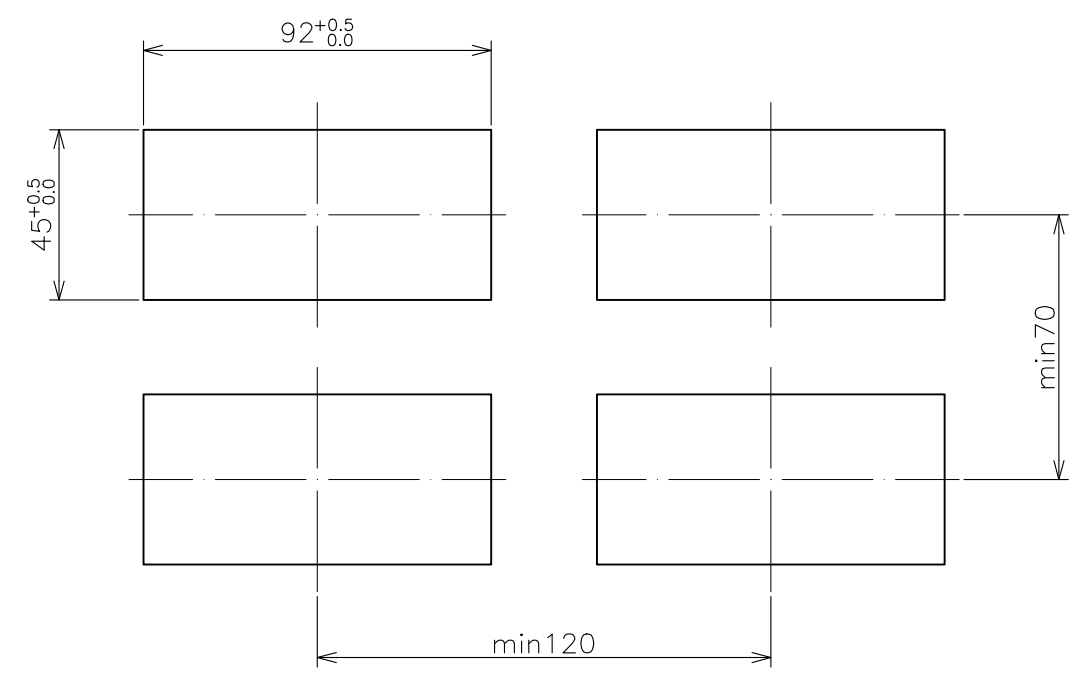

パネルカット
Panel cut-out dimension

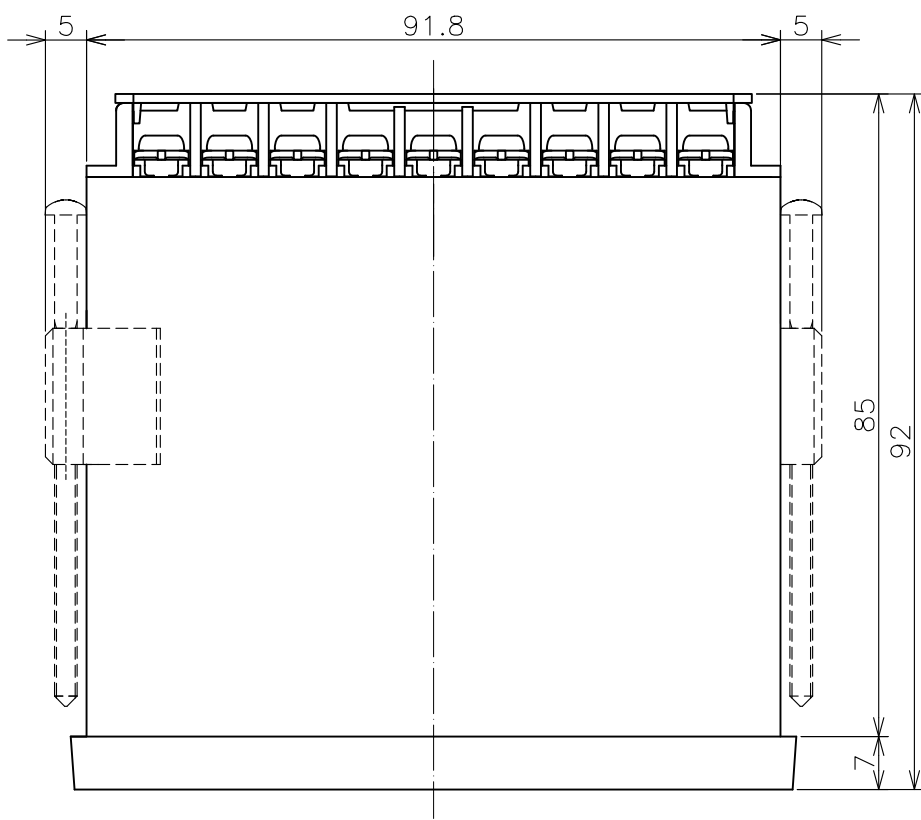
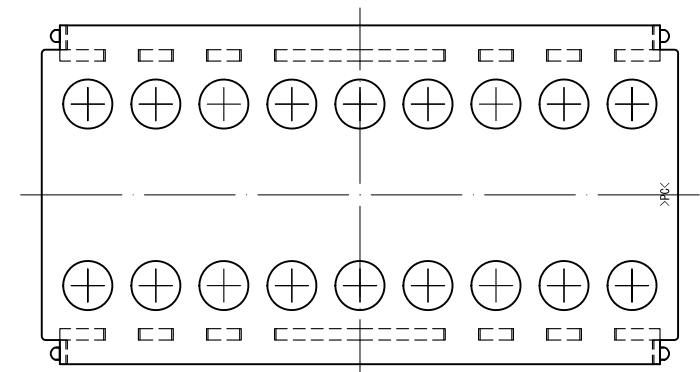

端子カバー (t=1.2)
Terminal cover (t=1.2)

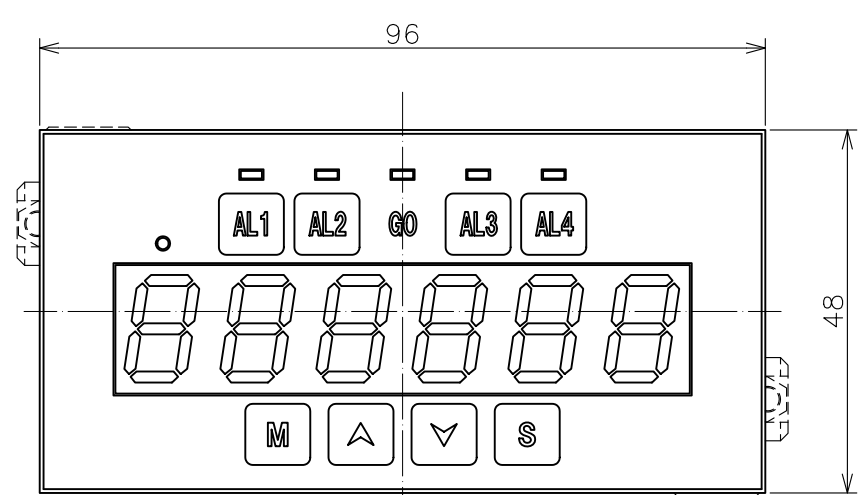

6digit

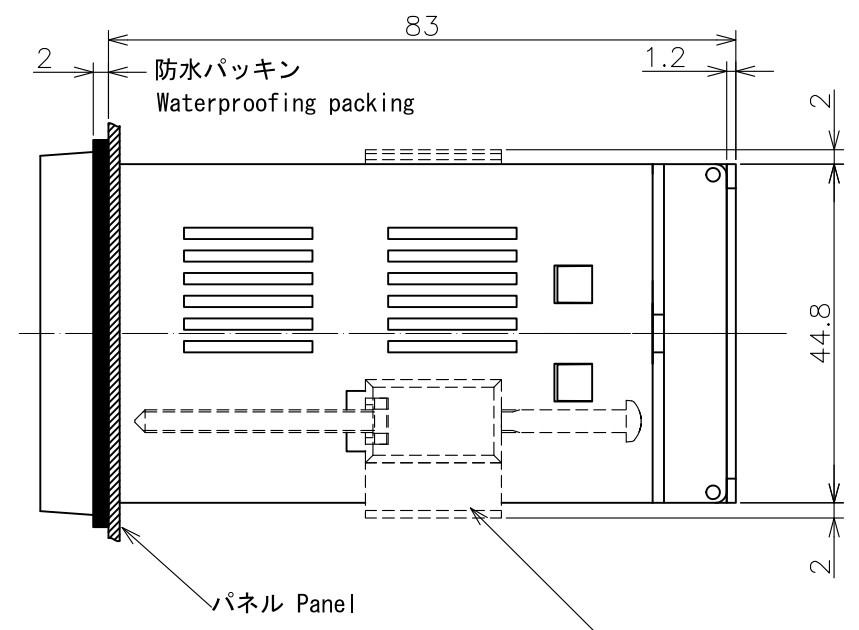

パネル Panel

取付具 (固定ネジ : M3)
Fixture (Fixed screw : M3)

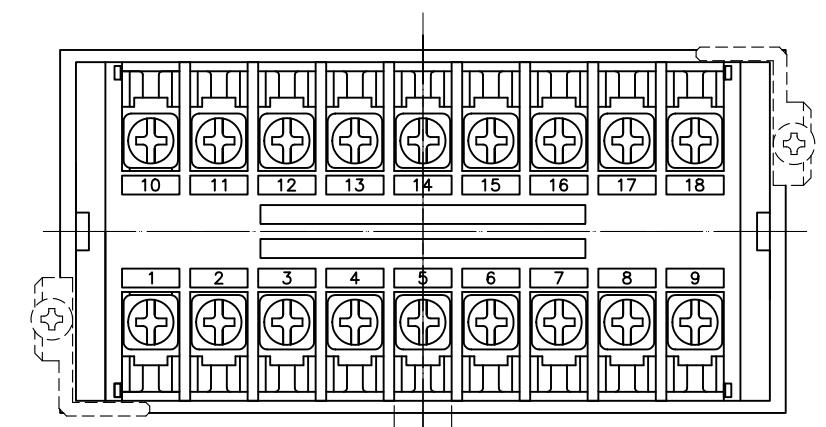

端子ネジ : M3.5
Terminal screws : M3.5

後部端子
rear side (terminal part)

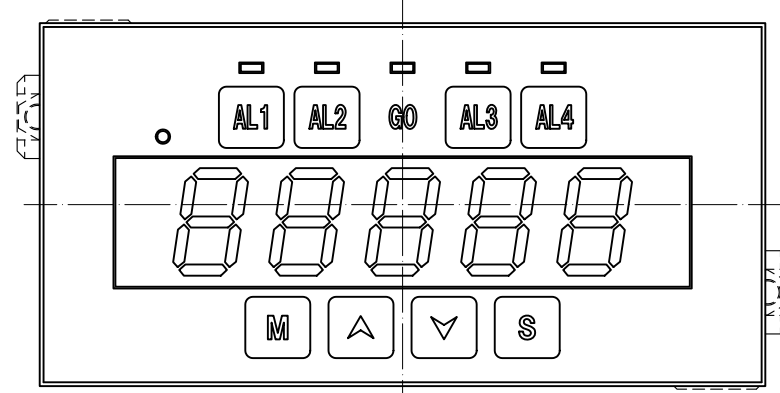

5digit

DESIGNED	CHECKED	APPROVED	SCALE	TYPE
			A3 1/1	M□65/M□55 series M□45/M□36 series
HENIX CORPORATION ヘニックス株式会社				TITLE 外形寸法図 dimension
				DRWN NO.